

OD1225 IP69K Series

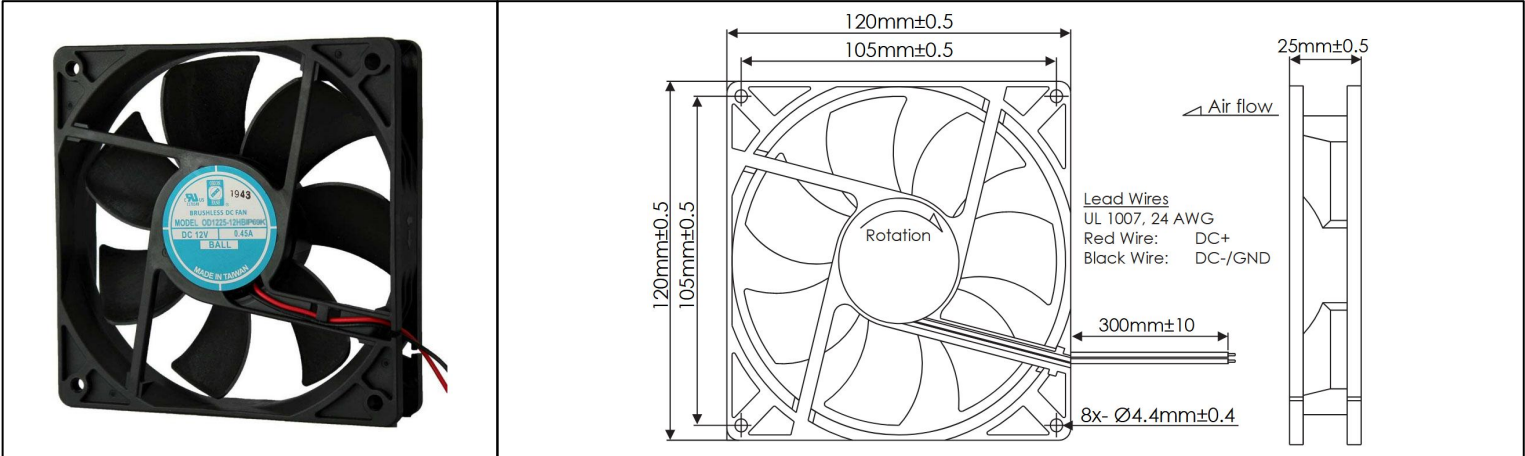

DC Fans - 12, 24, 48V
120mm x 25mm (4.7" x 1.0")



Frame	PBT, UL94 V-0 Plastic	Operating Temperature -20°C ~ +65°C Storage Temperature -20°C ~ +75°C Life Expectancy 60,000 Hours (L10 at 35°C) Available Options PWM Speed Control Input Tachometer Output Alarm Output 5 Volt Models Weight: 0.34 lbs.	
Impeller	PBT, UL94 V-0 Plastic		
Connection	2x Lead Wires, UL 1007 24 AWG		
Motor	Brushless DC, Auto Cutoff, Auto Restart, Polarity Protected, Electronically Protected, IP69K		
Bearing System	Dual Ball Bearings		
Dielectric Strength	500VDC/min, <1mA		
Insulation Resistance	≥10MΩ @ 500 VDC		

Part Number	Rated Voltage (Volts DC)	Voltage Range (Volts DC)	Input Power (Watts)	Rated Current (Amps)(Max)	Rated Speed (RPM)	Max Airflow (CFM)	Noise Level (dBA)	Max Static Pressure ("H ₂ O)
OD1225-12HBIP69K	12	8 ~ 13.8	5.4	0.45	3100	120	42	0.24"
OD1225-24HBIP69K	24	15 ~ 26	7.7	0.32	3100	120	42	0.24"
OD1225-48HBIP69K	48	28 ~ 52	8.6	0.18	3100	120	42	0.24"