

OA125EC Series

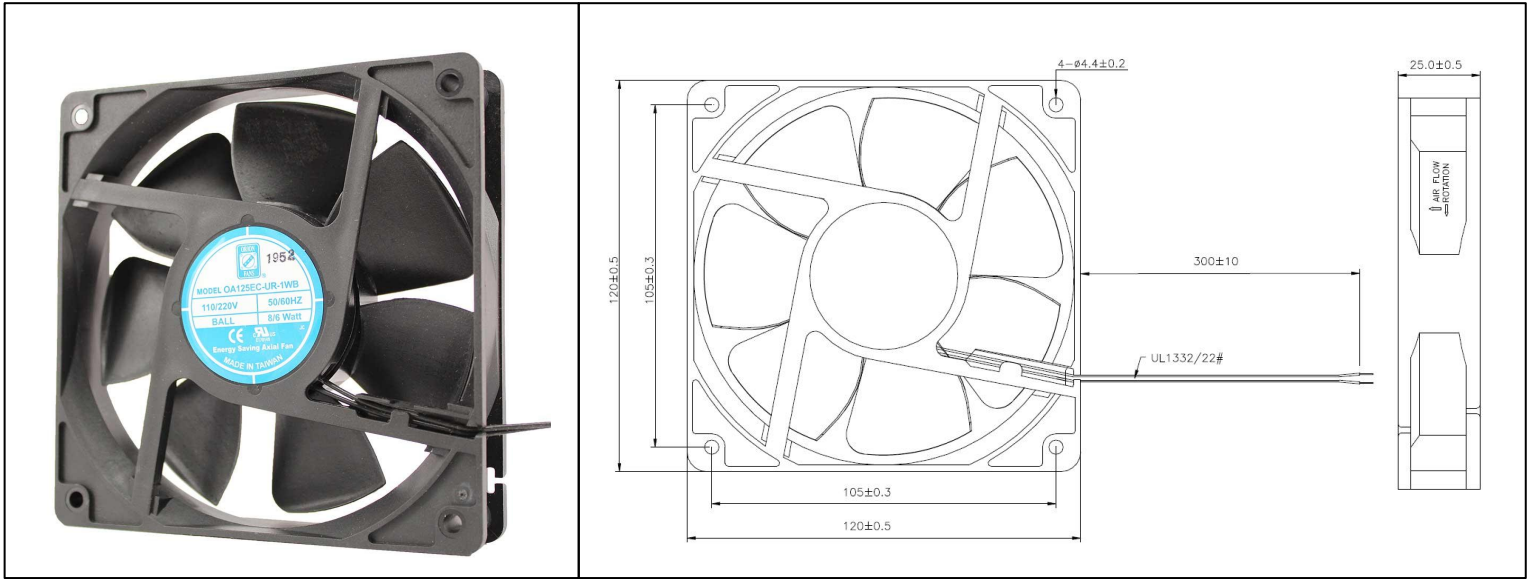

EC Fan Universal Voltage
120x25mm (4.72" x 0.98")



Frame	PBT UL94V0- Plastic	<u>Operating Temperature</u> -10C ~ +70C <u>Storage Temperature</u> -40C ~ +75C <u>Life Expectancy</u> 70,000 hours (L10 at 40C) Weight: ~ 0.39 lbs m0	
Impeller	PBT UL94V0- Plastic		
Connection	Wire Leads		
Motor	AC-DC Energy Saving, Electronically Protected		
Bearing System	Dual Ball Bearings		
Dielectric Strength	1500VAC/min		

Part Number	OA125EC-UR-1WB
Rated Voltage	110/220 VAC
Voltage Range	85 ~ 265
Rated Input	8 ~ 6 (2.8)W
Rated Speed (RPM)	3000
Airflow (CFM)	80
Noise Level (dB)	49
Max. Static Pressure	0.21"H ₂ O