

OD254 Series

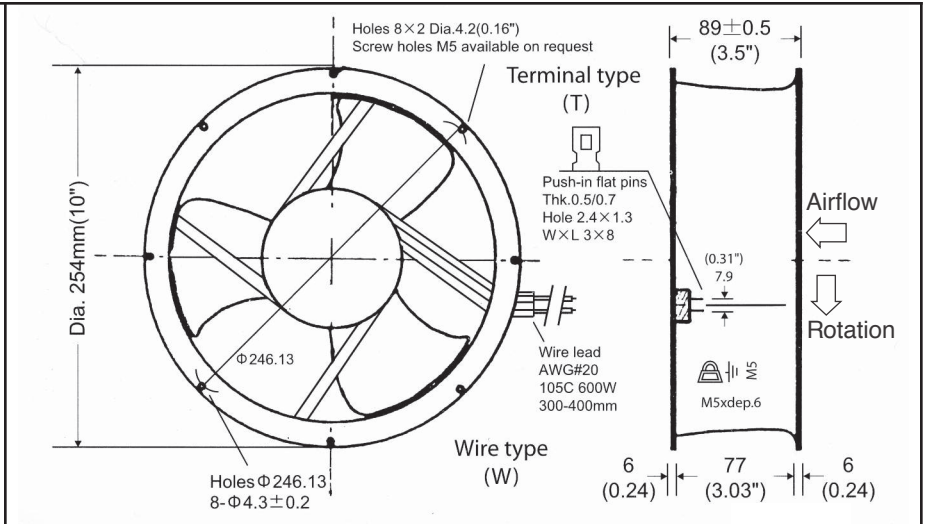

DC Fan - 12, 24, 48V
254x89mm (10.0"x 3.50")



Frame	Diecast Aluminum	Available Options: Tachometer Alarm Thermistor Speed Control PWM Speed Control Life Expectancy (L10) Ball - 40,000 hrs (60C) Operating Temperature Ball: -20C ~ +75C Weight: ~4.0 lbs m0	
Impeller	PBT, UL94V-0 plastic		
Connection	2x Lead wires 20AWG or terminals		
Motor	Brushless DC, auto restart, impedance and polarity protected		
Bearing System	Ball bearing		
Insulation Resistance	10M ohm between leadwire and frame (500VDC)		
Dielectric Strength	1 second at 500 VAC, max leakage < 500 MicroAmp		
Storage Temperature	-40C ~ +90C		

Model Number	Speed (RPM)	Airflow (CFM)	Noise (dB)	Volts DC	Voltage Range (VDC)	Input Power (Watt)	Amps	Max. Static Pressure ("H ₂ O)
OD254AP-12H *	2400	830	60	12	9~13	65	5.4	0.78
OD254AP-12M *	2000	690	47	12	9~13	23	4.2	0.58
OD254AP-12L *	1650	550	39	12	8~14	13	1.9	0.37
OD254AP-24H *	2500	850	64	24	16~27	64	2.65	0.83
OD254AP-24M *	2000	690	47	24	16~27	24	2.1	0.58
OD254AP-24L *	1650	550	39	24	16~27	13	0.97	0.37
OD254AP-48H *	2500	850	64	48	24~53	62	1.3	0.83
OD254AP-48M *	2000	690	47	48	24~53	24	1.03	0.58
OD254AP-48L *	1650	550	39	48	24~56	15	0.48	0.37

* Indicate "B" for wire leads or "TB" for Terminals